

PRESURIZADOR INTELIGENTE

EN 127V



AHORRO DE ENERGÍA



PRESIÓN CONSTANTE



MOTOR DE IMANES
PERMANENTES



SILENCIOSO



MÚLTIPLES
PROTECCIONES



i-DRO-26-1-127



i-DROX-18-2-127



AMBOS MODELOS
CUENTAN CON:

MÚLTIPLES
MODOS
DE FUNCIONAMIENTO



VÁLVULA CHECK
INTEGRADA



Por que no todas las aplicaciones son iguales, la serie IDRO le ofrece 3 distintos modos de funcionamiento los cuales puede ver en las siguientes ilustraciones:

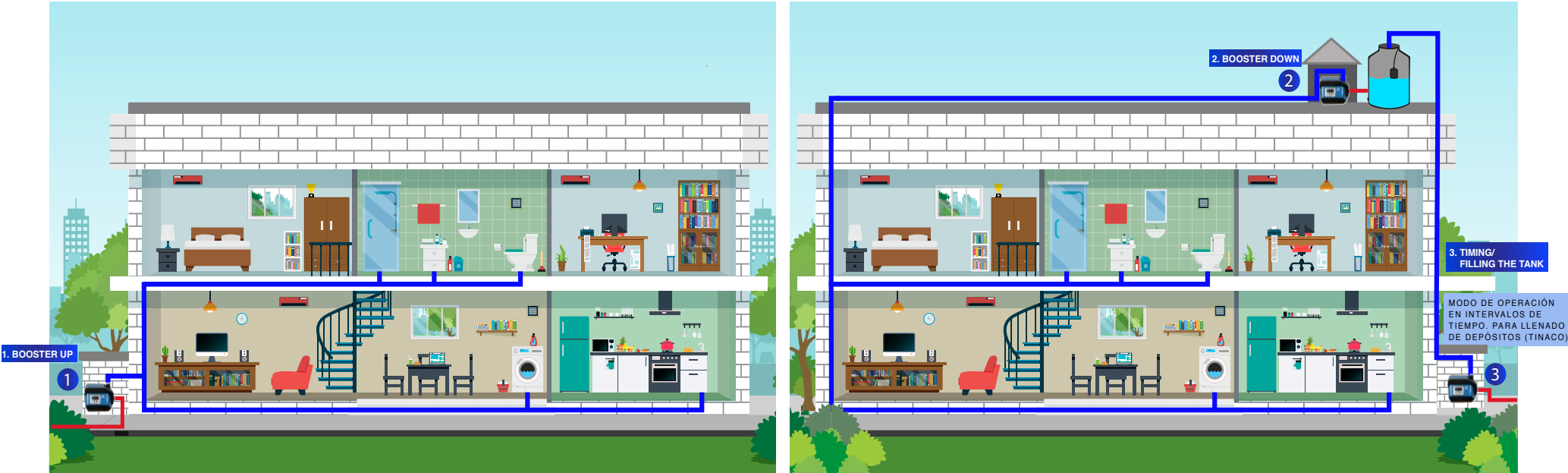

DESCRIPCIÓN DE CÓDIGO

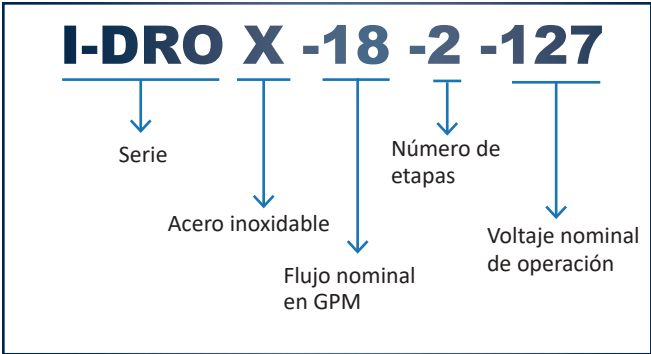

VENTAJAS

- Ahorro de energía
- Presión constante
- Motor de imanes permanentes
- Pantalla touch LCD
- 1m de cable tomacorriente con clavija



ESPECIFICACIONES

CÓDIGO	HP	KW	A	Fases x Volts	Succión x Descarga	Máximo desempeño	
						Carga (m)	Gasto (lpm)
I-DRO-26-1-127	1.47	1.1	6.3	1 x 127	1¼" x 1¼"	30	158.33



AUTOCEBANTE



CUERPO Y DIFUSOR EN HIERRO

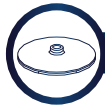

IMPULSOR EN LATÓN

CARACTERÍSTICAS DE OPERACIÓN

- Rango de voltaje de alimentación: 90 a 150 Vca
- Aislamiento: Clase F
- Rango de temperatura del líquido: 10°C a 60°C
- Temperatura ambiente: < 40°C
- Protección: IP 44

DIMENSIONES Y PESO

CÓDIGO	DIMENSIONES (mm)				PESO (kg)
	A	B	C	D	
I-DRO-26-1-127	244	284.5	426	185.5	15.4

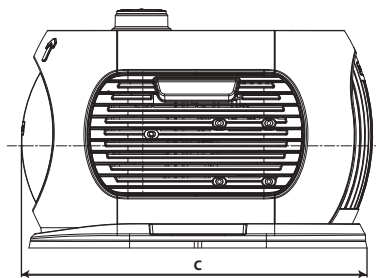
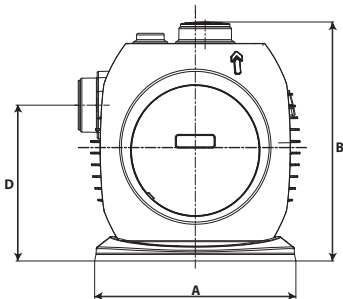

ÁREA DE OPERACIÓN

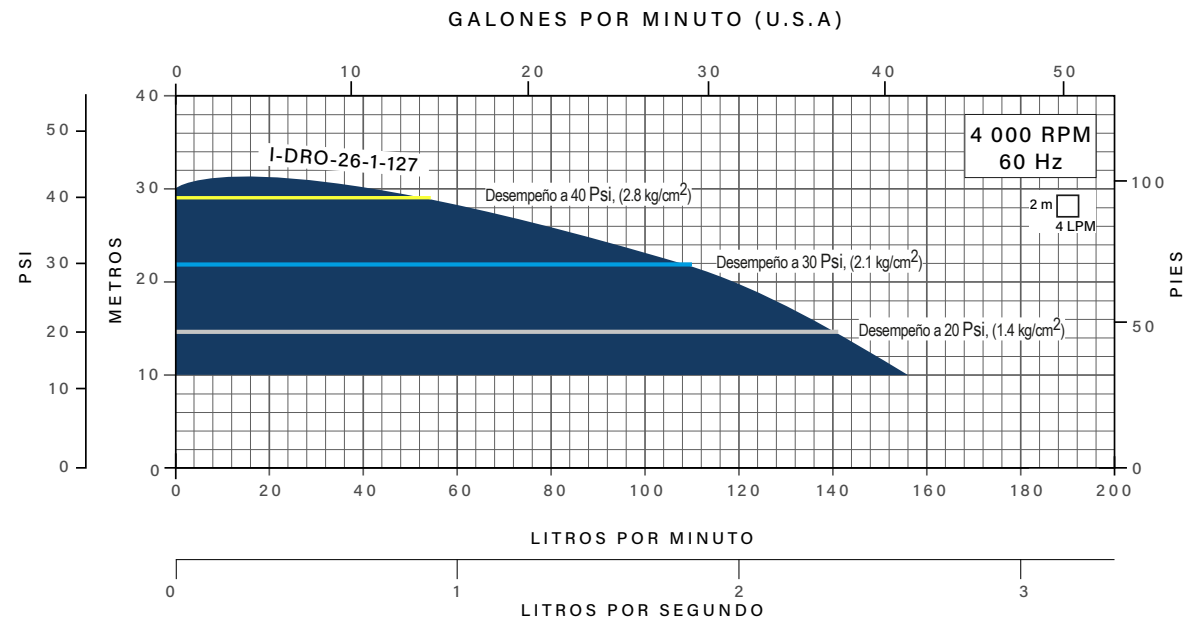

VENTAJAS

- Ahorro de energía
- Presión constante
- Motor de imanes permanentes
- Pantalla LCD
- 1m de cable tomacorriente con clavija



ESPECIFICACIONES

CÓDIGO	HP	KW	A	Fases x Volts	Succión x Descarga	Máximo desempeño	
						Carga (m)	Gasto (lpm)
I-DROX-18-2-127	1	0.75	8	1x127	1½" x 1"	37	155



CUERPO DE BOMBA EN ACERO INOXIDABLE

IMPULSOR Y DIFUSOR ACERO INOXIDABLE

ÁREA DE OPERACIÓN

CARACTERÍSTICAS DE OPERACIÓN

- Rango de voltaje de alimentación: 90 a 150 Vca
- Aislamiento: clase F
- Rango de temperatura del líquido: 10°C a 60°C
- Temperatura ambiente: < 40°C
- Protección: IP 44

DIMENSIONES Y PESO

CÓDIGO	DIMENSIONES (mm)				PESO (kg)
	A	B	C	D	
I-DROX-18-2-127	271	275	366	90	11

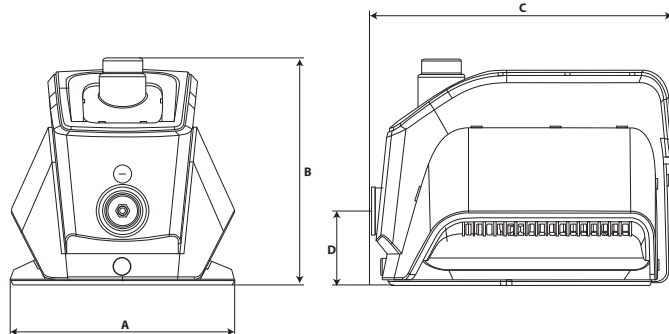

GALONES POR MINUTO (U.S.A)

